

### VIGAS DO PAVIMENTO TÉRREO MBP 40A/B

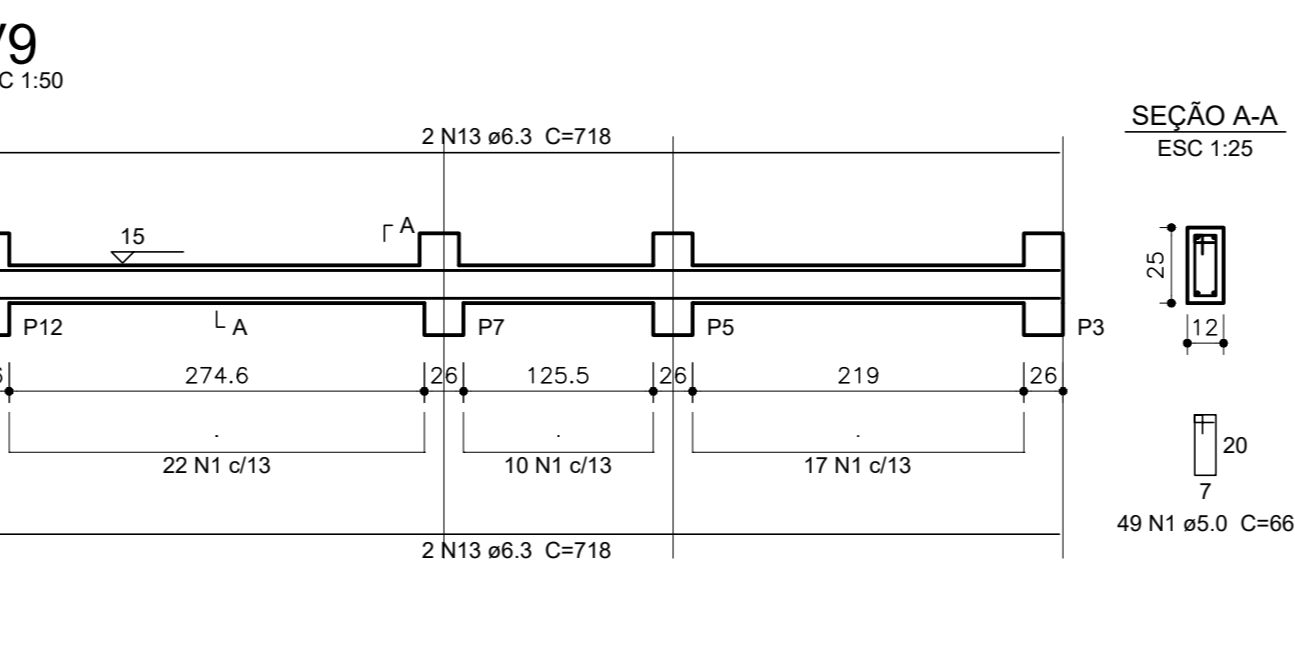

### VIGAS DO PAVIMENTO SUPERIOR MBP 40A/B

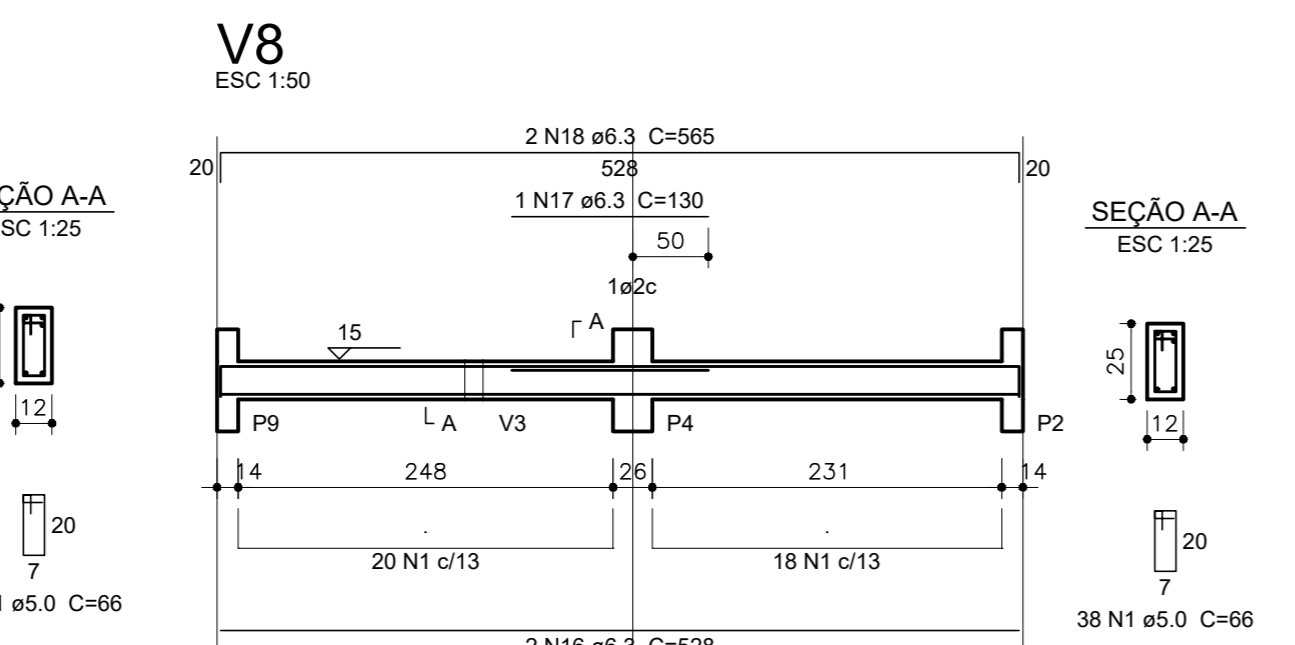
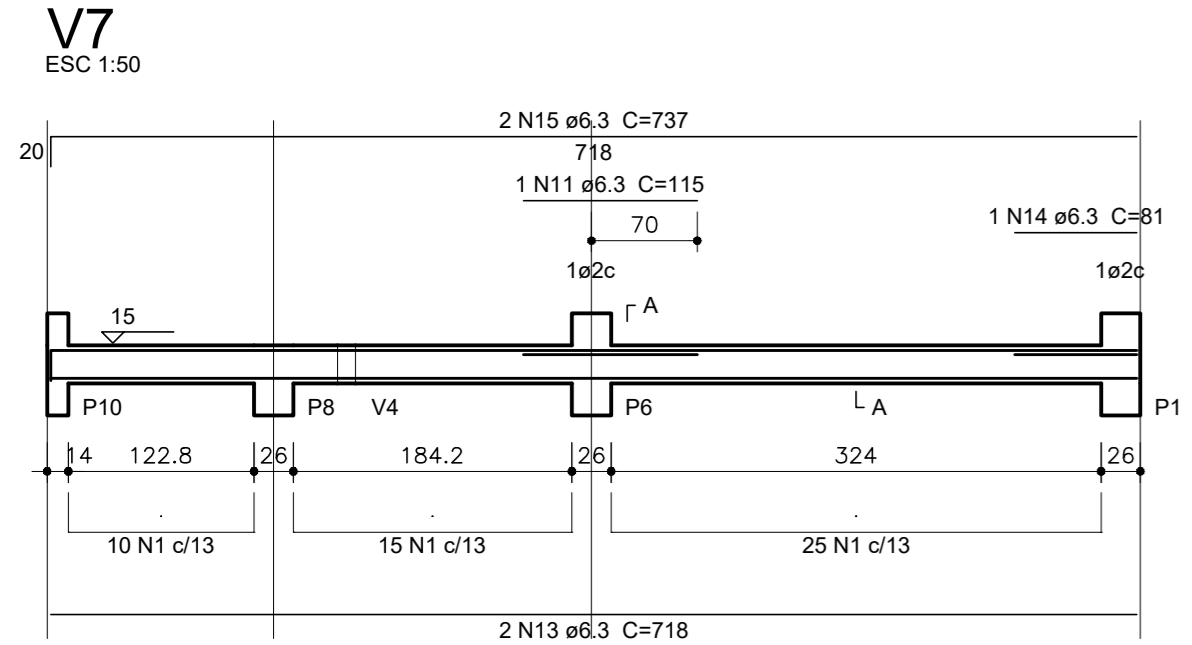
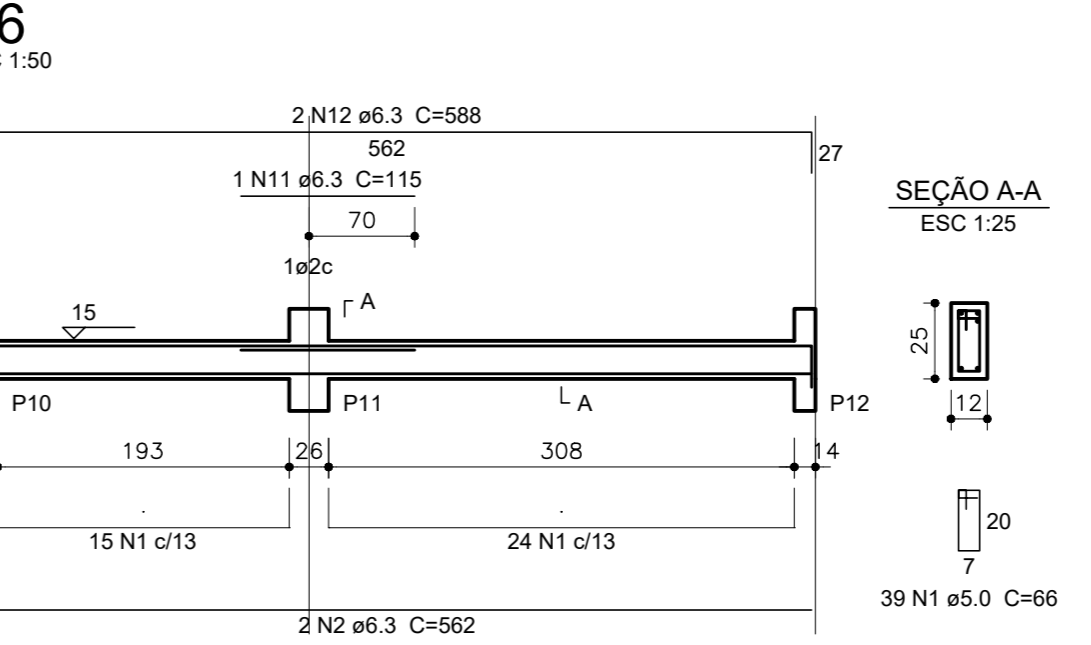
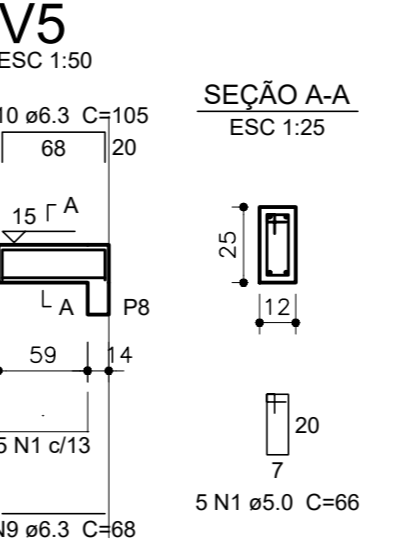
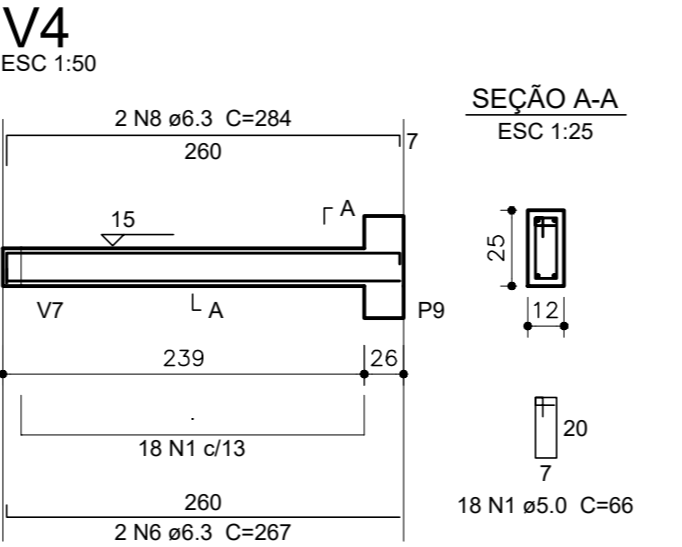
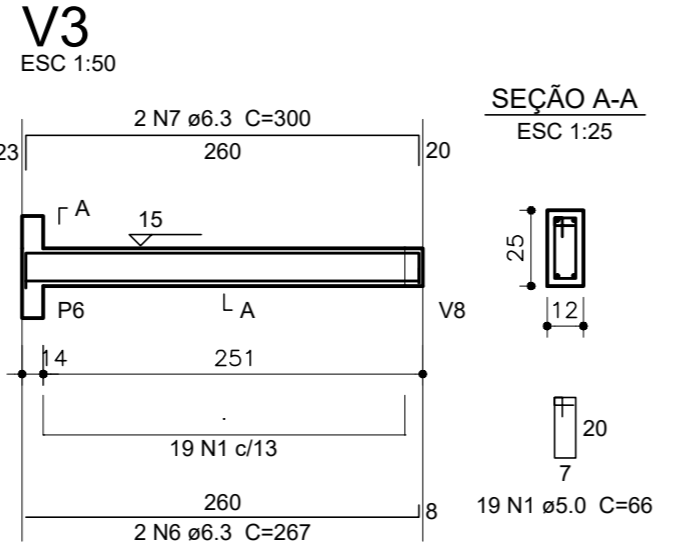
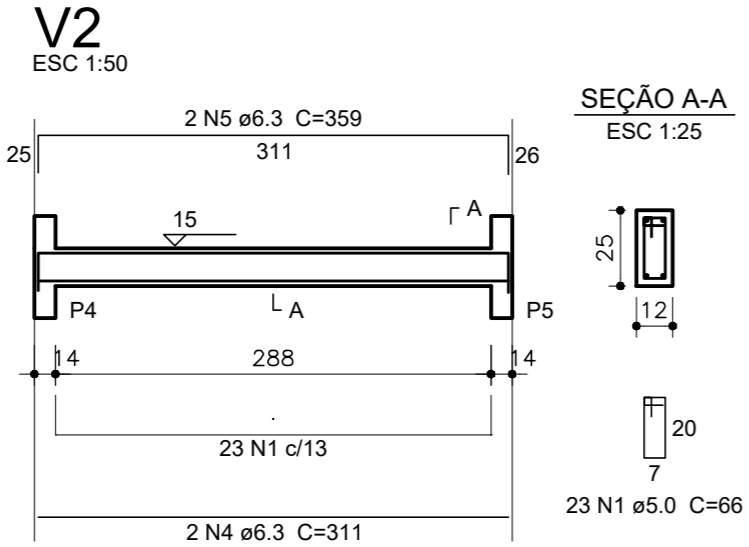
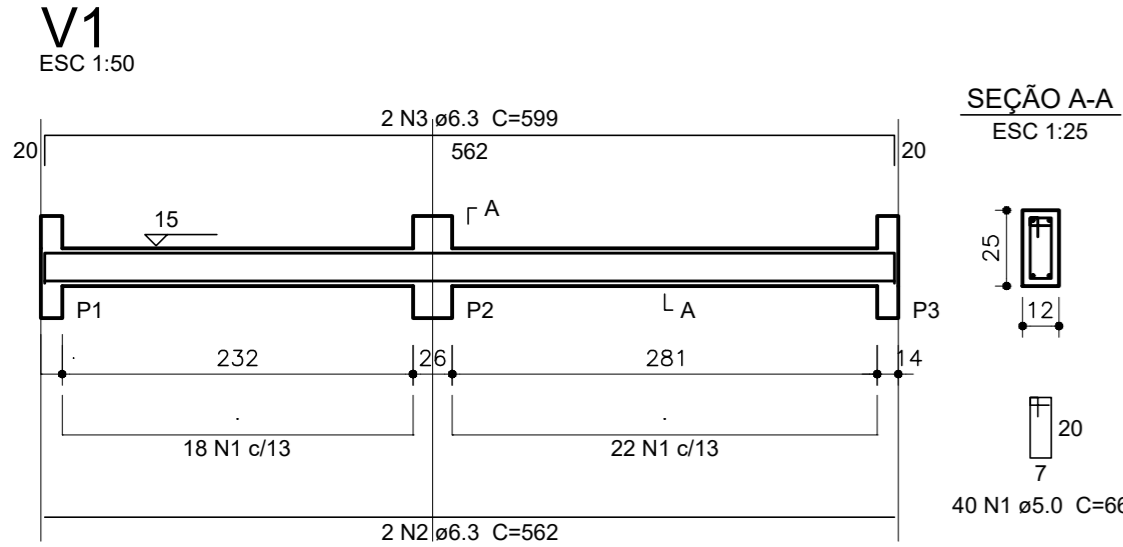
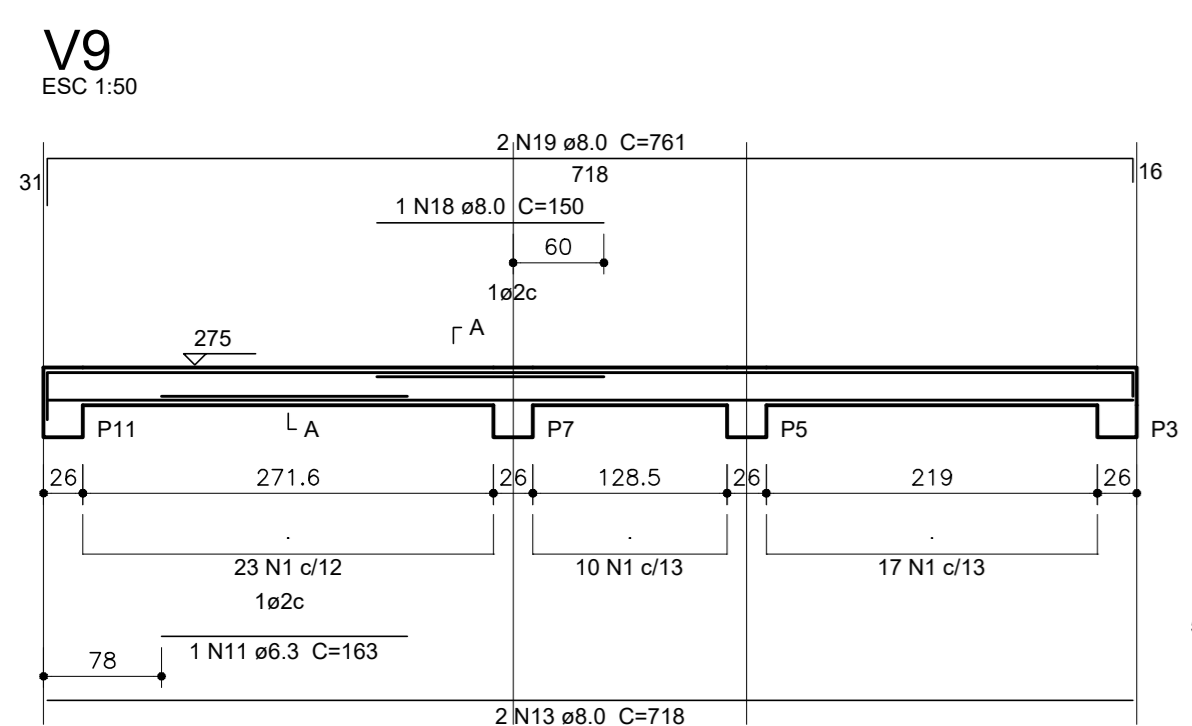
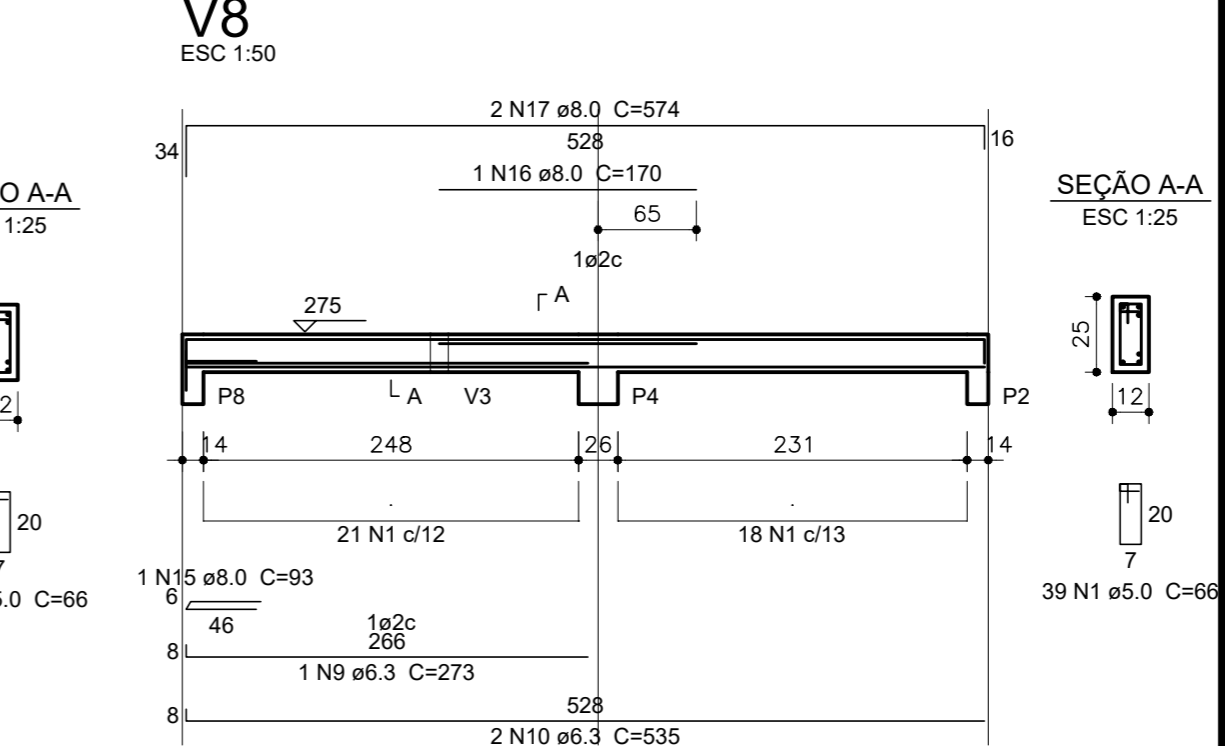
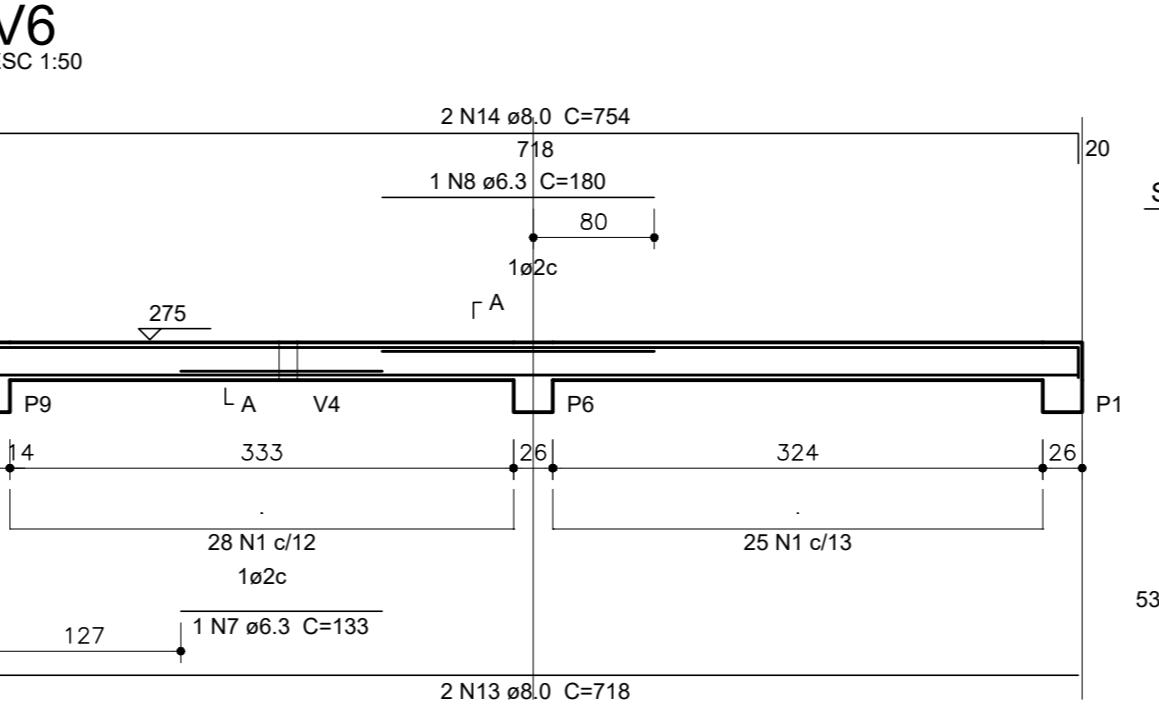
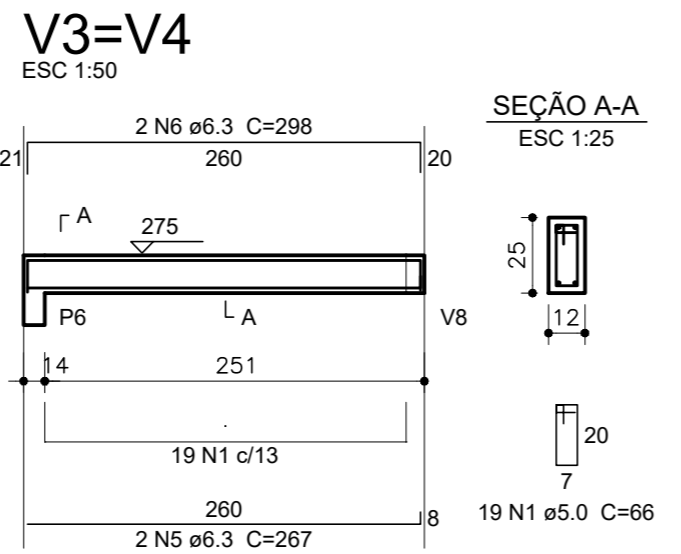
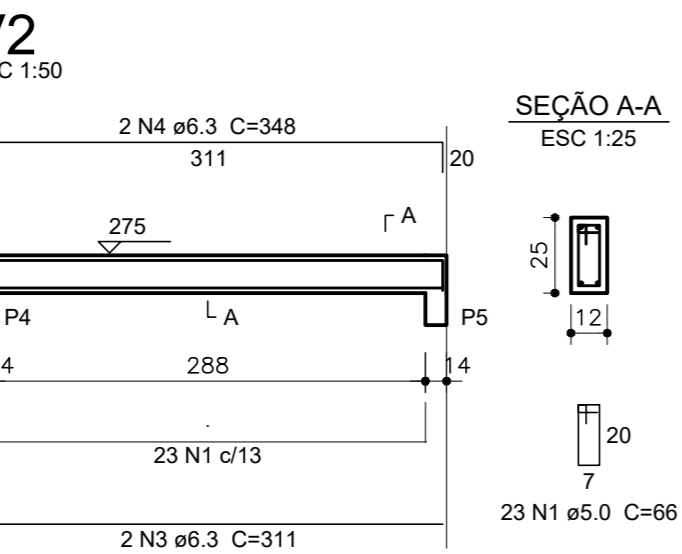
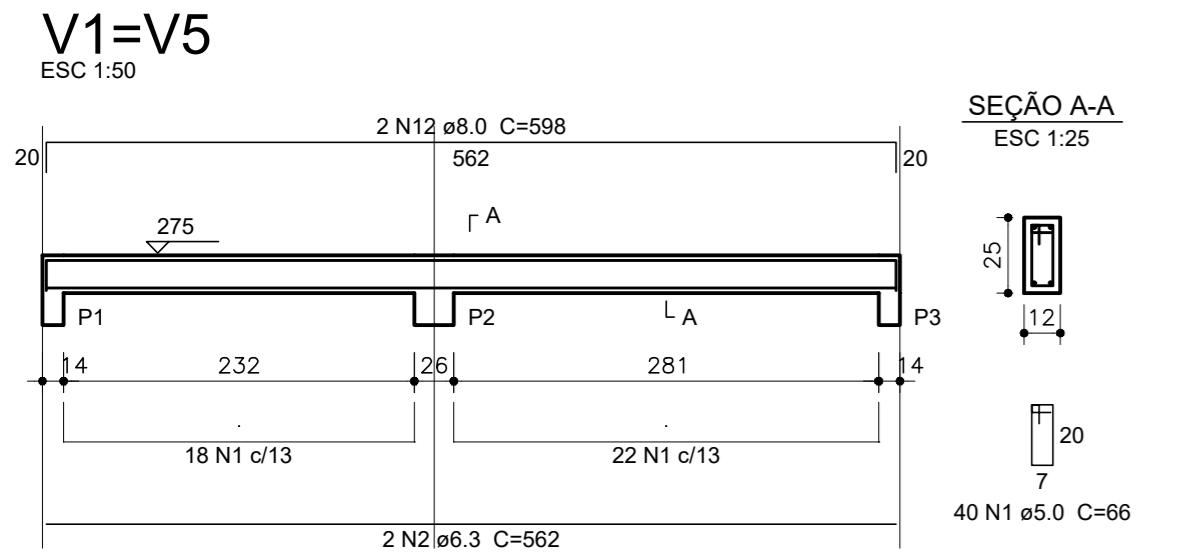

#### Relação do aço

AÇO	N	DIAM (mm)	QUANT (Barras)	UNIT (cm)	C.TOTAL (cm)
CA60	1	5.0	281	66	18546
CA50	2	6.3	4	562	2248
	3	6.3	2	599	1198
	4	6.3	2	311	622
	5	6.3	2	359	718
	6	6.3	4	267	1068
	7	6.3	2	300	600
	8	6.3	2	284	568
	9	6.3	2	68	136
	10	6.3	2	105	210
	11	6.3	2	115	230
	12	6.3	2	588	1176
	13	6.3	6	718	4308
	14	6.3	1	81	81
	15	6.3	2	737	1474
	16	6.3	2	528	1056
	17	6.3	1	130	130
	18	6.3	2	565	1130

#### Resumo do aço

AÇO	DIAM (mm)	C.TOTAL (m)	PESO + 10% (kg)
CA50	6.3	169.6	45.6
CA60	5.0	185.5	31.4
<b>PESO TOTAL (kg)</b>			
CA50	45.6		
CA60	31.4		

Volume de concreto (C-20) = 1.21 m³  
Área de forma = 25 m²

#### USO EXCLUSIVO DA COHAPAR

REVISÕES				AUTOR
REV	DATA	DESCRIÇÃO		DVIE / R_RUY
R00	07/03/2017	EMISSÃO INICIAL		

g:\dvie\dpo\projetos 2017\mbp40 a b reb gem1 meio giro fam par\est mbp40 a b reb gem1 meio giro fam par.dwg

#### USO EXCLUSIVO DA COHAPAR

RESPONSÁVEL TÉCNICO: \_\_\_\_\_

CONTROLE DE CÓPIAS

# COHAPAR COHAPAR

#### Relação do aço

AÇO	N	DIAM (mm)	QUANT (Barras)	UNIT (cm)	C.TOTAL (cm)
CA60	1	5.0	283	66	18678
CA50	2	6.3	4	562	2248
	3	6.3	2	311	622
	4	6.3	2	348	696
	5	6.3	4	267	1068
	6	6.3	4	298	1192
	7	6.3	1	133	133
	8	6.3	1	180	180
	9	6.3	1	273	273
	10	6.3	2	535	1070
	11	6.3	1	163	163
	12	8.0	4	598	2392
	13	8.0	4	718	2872
	14	8.0	2	754	1508
	15	8.0	1	93	93
	16	8.0	1	170	170
	17	8.0	2	574	1148
	18	8.0	1	150	150
	19	8.0	2	761	1522

#### Resumo do aço

AÇO	DIAM (mm)	C.TOTAL (m)	PESO + 10% (kg)
CA50	6.3	76.5	20.6
	8.0	98.6	42.8
CA60	5.0	186.8	31.7
<b>PESO TOTAL (kg)</b>			
CA50	63.4		
CA60	31.7		

Volume de concreto (C-20) = 1.19 m³  
Área de forma = 24.55 m²



PRANCHA	REVISÃO
EST 02 02	R 00

**MBP 40A/B**  
40,99m²  
**FAMÍLIA PARANAENSE**

MORAR BEM PARANÁ

autor projeto	autor desenho
R.MANTOVANI	R_RUY
escala	data de criação
INDICADAS	MAR / 2017

**PROJETO ESTRUTURAL**  
VIGAS DO PAV. INFERIOR E PAV. SUPERIOR

nome do arquivo	SALVO EM
P40 A B reb GEM1 Meio Giro Fam	15/03/2017
HISTÓRICO	IMPRESSO EM
	16/03/2017
	SALVO POR
	RODRIGUE